



## SISTEMI PAMETNIH KUĆA - GRENTON

**GRENTON** sistemi pametnih kuća Vam pružaju - **UŠTEDU - KOMFOR - FLEKSIBILNOST - SIGURNOST**

Laka, brza i jednostavna kontrola Svetla, Grejanja i Hlađenja, AV opreme, Sigurnosnih sistema zaštite, Uštede električne energije.

Bilo koje svetlo	Podešavanje jačine	Promena boje	Merenje potrošnje	Blagi start	Razne scene
Svako grejno telo	Više zona grejanja	Kontrola temperature	Praktični programi	Odošljeni start	Značajna ušteda
Pametna kontrola	Zalivni sistemi	Daljinska kontrola i upravljanje	Kuća i bašta	Prilagodljiv raspored	Jačina u skladu sa mesečevim fazama
Audio kontrola	Video kontrola	Bezbednost	Kontrola roditelja		

### KOMBINACIJA TRADICIONALNOG OŽIČENJA I SAVREMENE TF-BUS GRENTON TOPOLOGIJE

- gde nije moguća prepravka stare kablaze postavljaju se bežični moduli -

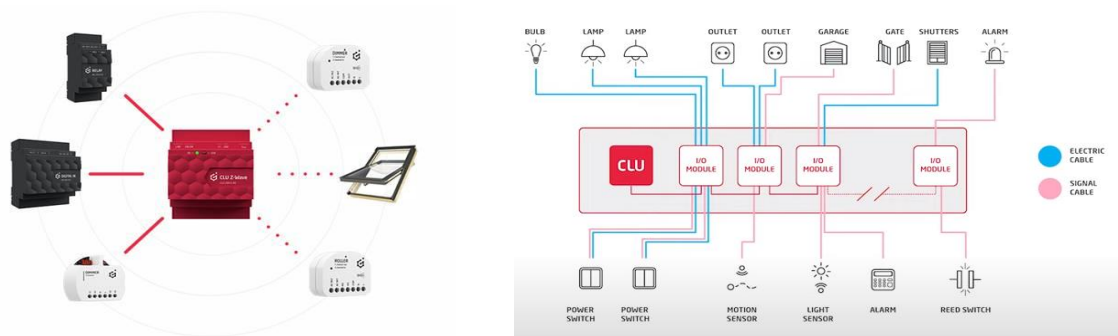



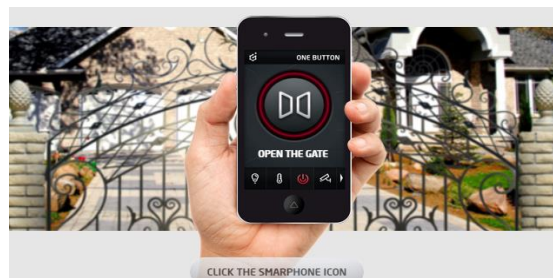

### BESPLATNA APLIKACIJA ZA PAMETNE TELEFONE I TABLET UREĐAJE











## SISTEMI PAMETNIH KUĆA - GRENTON







### SMART PANELI

Slika	Sifra	Naziv	Marka	Model
	136680	<b>Smart Panel 4B, OLED, TF-Bus, crni</b> Za kontrolu svetla i bilo kog drugog uređaja koji je povezan u sistemu pametne kuće. Lak pristup podacima svakog detektora i prikaz statusa. Ugrađen senzor za merenje temperature i intenziteta svetlosti.		SPS-204-T-01
	136681	<b>Smart Panel 4B, OLED, TF-Bus, beli</b> Za kontrolu svetla i bilo kog drugog uređaja koji je povezan u sistemu pametne kuće. Lak pristup podacima svakog detektora i prikaz statusa. Ugrađen senzor za merenje temperature i intenziteta svetlosti.		SPS-204-T-02



### TOUCH PANELI

	136682	<b>Touch Panel 4B, TF-Bus, crni</b> 4 programabilna tastera osetljiva na dodir sa 4 nezavisne funkcije svaki, ugrađen temperaturni senzor i bazer, indikacija statusa svakog tastera, laka instalacija. Ugrađen senzor za merenje temperature i intenziteta svetlosti.		TPA-204-T-01
	136683	<b>Touch Panel 4B, TF-Bus, beli</b> 4 programabilna tastera osetljiva na dodir sa 4 nezavisne funkcije svaki, ugrađen temperaturni senzor i bazer, indikacija statusa svakog tastera, laka instalacija. Ugrađen senzor za merenje temperature i intenziteta svetlosti.		TPA-204-T-02
	136684	<b>Touch Panel 8B, TF-Bus, crni</b> 8 programabilnih tastera osetljivih na dodir sa 4 nezavisne funkcije svaki, ugrađen temperaturni senzor i bazer, indikacija statusa svakog tastera, laka instalacija. Ugrađen senzor za merenje temperature i intenziteta svetlosti.		TPA-208-T-01
	136685	<b>Touch Panel 8B, TF-Bus, beli</b> 8 programabilnih tastera osetljivih na dodir sa 4 nezavisne funkcije svaki, ugrađen temperaturni senzor i bazer, indikacija statusa svakog tastera, laka instalacija. Ugrađen senzor za merenje temperature i intenziteta svetlosti.		TPA-208-T-02



### TOUCH PANELI sa ikonicama

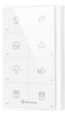

		<b>Touch Panel 4B sa ikonicama, TF-Bus, crni</b> 4 programabilna tastera sa ikonicama osetljiva na dodir sa 4 nezavisne funkcije svaki, ugrađen temperaturni senzor i bazer, indikacija statusa svakog tastera. Ugrađen senzor za merenje temperature i intenziteta svetlosti.		TPA-404-T-01
		<b>Touch Panel 4B sa ikonicama, TF-Bus, beli</b> 4 programabilna tastera sa ikonicama osetljiva na dodir sa 4 nezavisne funkcije svaki, ugrađen temperaturni senzor i bazer, indikacija statusa svakog tastera, laka instalacija. Ugrađen senzor za merenje temperature i intenziteta svetlosti.		TPA-404-T-02
		<b>Touch Panel 8B sa ikonicama, TF-Bus, crni</b> 8 programabilnih tastera sa ikonicama osetljivih na dodir sa 4 nezavisne funkcije svaki, ugrađen temperaturni senzor i bazer, indikacija statusa svakog tastera. Ugrađen senzor za merenje temperature i intenziteta svetlosti.		TPA-408-T-01



**TOUCH PANELI sa ikonicama**



Slika	Sifra	Naziv	Marka	Model
		<b>Touch Panel 8B sa ikonicama, TF-Bus, beli</b> 8 programabilnih tastera sa ikonicama osjetljivih na dodir sa 4 nezavisne funkcije svaki, ugrađen temperaturni senzor i bazer, indikacija statusa svakog tastera. Ugrađen senzor za merenje temperature i intenziteta svetlosti.		TPA-408-T-02

**TOUCH PANELI - dekor drvo**



		<b>Touch Panel 4B, TF-Bus, dekor drvo tamni</b> 4 programabilna tastera osjetljiva na dodir sa 4 nezavisne funkcije svaki, ugrađen temperaturni senzor i bazer, indikacija statusa svakog tastera, laka instalacija. Ugrađen senzor za merenje temperature i intenziteta svetlosti.		TPA-604-T-01
---	--	--	---	--------------



		<b>Touch Panel 4B, TF-Bus, dekor drvo svetli</b> 4 programabilna tastera osjetljiva na dodir sa 4 nezavisne funkcije svaki, ugrađen temperaturni senzor i bazer, indikacija statusa svakog tastera, laka instalacija. Ugrađen senzor za merenje temperature i intenziteta svetlosti.		TPA-604-T-02
---	--	---	---	--------------



		<b>Touch Panel 8B, TF-Bus, dekor drvo tamni</b> 8 programabilnih tastera osjetljivih na dodir sa 4 nezavisne funkcije svaki, ugrađen temperaturni senzor i bazer, indikacija statusa svakog tastera, laka instalacija. Ugrađen senzor za merenje temperature i intenziteta svetlosti.		TPA-608-T-01
---	--	--	---	--------------



		<b>Touch Panel 8B, TF-Bus, dekor drvo svetli</b> 8 programabilnih tastera osjetljivih na dodir sa 4 nezavisne funkcije svaki, ugrađen temperaturni senzor i bazer, indikacija statusa svakog tastera, laka instalacija. Ugrađen senzor za merenje temperature i intenziteta svetlosti.		TPA-608-T-02
--	--	---	--	--------------

**TOUCH PANELI - dekor koža**

		<b>Touch Panel 4B, TF-Bus, dekor koža tamni</b> 4 programabilna tastera osjetljiva na dodir sa 4 nezavisne funkcije svaki, ugrađen temperaturni senzor i bazer, indikacija statusa svakog tastera, laka instalacija. Ugrađen senzor za merenje temperature i intenziteta svetlosti.		TPA-804-T-01
---	--	--	---	--------------

		<b>Touch Panel 4B, TF-Bus, dekor koža svetli</b> 4 programabilna tastera osjetljiva na dodir sa 4 nezavisne funkcije svaki, ugrađen temperaturni senzor i bazer, indikacija statusa svakog tastera, laka instalacija. Ugrađen senzor za merenje temperature i intenziteta svetlosti.		TPA-804-T-02
---	--	---	---	--------------





		<b>Touch Panel 8B, TF-Bus, dekor koža tamni</b> 8 programabilnih tastera osjetljivih na dodir sa 4 nezavisne funkcije svaki, ugrađen temperaturni senzor i bazer, indikacija statusa svakog tastera, laka instalacija. Ugrađen senzor za merenje temperature i intenziteta svetlosti.		TPA-808-T-01
---	--	--	---	--------------

		<b>Touch Panel 8B, TF-Bus, dekor koža svetli</b> 8 programabilnih tastera osjetljivih na dodir sa 4 nezavisne funkcije svaki, ugrađen temperaturni senzor i bazer, indikacija statusa svakog tastera, laka instalacija. Ugrađen senzor za merenje temperature i intenziteta svetlosti.		TPA-808-T-02
---	--	---	---	--------------







## Moduli za montažu na DIN šinu

Slika	Sifra	Naziv	Marka	Model
	136686	<b>Glavni kontrolni modul, Z-wave, Eth, DIN, TF-Bus</b> Centralna jedinica za komunikaciju sa svim modulima, montira se na DIN šinu, ugrađen bežični prijemnik Z-wave.		CLU-200-E-00
	136687	<b>Analogni I/O modul, 0-10V, DIN, TF-Bus</b> 4 digitalna ulaza 0-10V, 2 digitalna ulaza 0-5V, 4 digitalna izlaza 0-10V, modul se kontroliše od strane CLU kontrolera		MUL-211-D-01
	136688	<b>Digitalni 6+3 modul, DIN, TF-Bus</b> 6 binarnih ulaza + 3 ulaza 230Vac, modul se kontroliše od strane CLU kontrolera		INP-209-D-01
	136689	<b>Dimer mosfet modul, DIN, TF-Bus</b> Modul za dimovanje, fino podešavanje i kontrolu osvetljenja, modul se kontroliše od strane CLU kontrolera		DIM-211-D-01
	136690	<b>MODBUS modul, DIN, Ethr</b> Modul za integraciju sa drugim sistemima (grejanja, hlađenja...) koji rade na Modbus RTU protokolu.		INT-201-E-01
	136692	<b>HTTP modul, DIN, Ethr</b> Modul za integraciju sa raznim internet servisima, kao i drugim uređajima koji podržavaju HTTP i HTTPS. (multimedija, servisi za prognozu vremena...).		INT-211-E-01
	136693	<b>LED RGBW modul, DIN, TF-Bus</b> Modul za kontrolu kolor, i belih LED traka. Kontrolise se od strane CLU kontrolera.		RGB-201-D-01
	136694	<b>Modul 2 relejna izlaza 230Vac, DIN, TF-Bus</b> Modul za kontrolu do 2 uređaja koja rade na 230Vac. Kontrolise se od strane CLU kontrolera.		REL-202-D-01
	136695	<b>Modul 4 relejna izlaza 230Vac, DIN, TF-Bus</b> Modul za kontrolu do 4 uređaja koja rade na 230Vac. Kontrolise se od strane CLU kontrolera.		REL-204-D-01
	136696	<b>Roller Shutter x1 modul, DIN, TF-Bus</b> Modul za upravljanje različitih tipova električnih roletni 230Vac. Kontrolise se od strane CLU kontrolera.		RSH-201-D-01
	136699	<b>Roller Shutter x3 modul, DIN, TF-Bus</b> Modul za upravljanje različitih tipova električnih roletni 230Vac, do 3 roletne. Kontrolise se od strane CLU kontrolera.		RSH-203-D-01











## Moduli za montažu na DIN šinu

Slika	Sifra	Naziv	Marka	Model
	136697	<b>Modul sa 8 ulaza/8 izlaza, DIN, TF-Bus</b> Za kontrolu do 8 izlaza (max.360VA) i 8 digitalnih ulaza. Kontroliše se od strane CLU kontrolera.		INO-288-D-01
	136698	<b>BUS raširitelj modul, DIN, TF-Bus</b> Modul za povezivanje TF-Bus-a u polju, za proširenja sistema i pravilno povezivanje napajanja kako bi se obezbedio pravilan rad uređaja.		BUS-201-D-01
		<b>DALI kontroler, DIN, TF-Bus</b> Modul za kontrolu do 64 pojedinačne sijalice koje podržavaju DALI standard. Max dužina bus-a do 300m sa kablom 2.5mm <sup>2</sup> , ili do 100m sa kablom 0.5mm <sup>2</sup> .		INT-202-D-01







## Moduli za ugradnu montažu

	136700	<b>Modul sa 2 ulaza/2 izlaza, ugradni, TF-Bus</b> Za kontrolu do 2 izlaza i 2 digitalnih ulaza. Kontroliše se od strane CLU kontrolera.		INO-222-T-01
	136701	<b>Roller Shutter x1 modul, ugradni, TF-Bus</b> Modul za upravljanje različitim tipova električnih roletni 230Vac. Kontroliše se od strane CLU kontrolera.		RHS-201-T-01
	136702	<b>LED RGBW modul, ugradni, TF-Bus</b> Modul za kontrolu kolor, i belih LED traka. Kontroliše se od strane CLU kontrolera.		RGB-201-T-01

## Bežični Moduli za ugradnu montažu AEOTEC

	136703	<b>Dual Nano modul, 2 izlaza, Z-Wave</b> Kontrola do 2 uređaja (šuko, prekidač), bežična Z-wave komunikacija sa CLU kontrolerom. Opterećenje do 5A/1150W po 1 izlazu.		REL-021-Z-AE
		<b>Nano modul, 1 izlaz, Z-Wave</b> Kontrola 1 uređaja (šuko ili prekidač), bežična Z-wave komunikacija sa CLU kontrolerom. Opterećenje do 5A/1150W.		REL-011-Z-AE
	136704	<b>Nano dimmer modul, Z-Wave</b> Modul za dimovanje, fino podešavanje i kontrolu osvetljenja, bežična Z-wave komunikacija sa CLU kontrolerom.		DIM-001-Z-AE
	136705	<b>Nano Shuter modul, Z-Wave</b> Modul za upravljanje različitim tipova električnih roletni 230Vac, bežična Z-wave komunikacija sa CLU kontrolerom.		RSH-011-Z-AE
	136706	<b>Bypass za Nano dimmer modul</b> Uređaj koji sprečava da dimovana sijalica nakog gašenja treperi ili blago sija. Ako se dimerom kontrolišu sijalice potrošnje do 4W moguća je potreba bypass uređaja.		ACC-001-Z-AE





















## Napajanja za montažu na DIN šinu

Slika	Sifra	Naziv	Marka	Model
		<b>Napajanje DC 24V, 0.6A, DIN</b> Koristi se za napajanje modula u sistemu.		PSU-240-6-01
	136707	<b>Napajanje DC 24V, 1.5A, DIN</b> Koristi se za napajanje modula u sistemu.		PSU-241-5-01
	136708	<b>Napajanje DC 24V, 2.5A, DIN</b> Koristi se za napajanje modula u sistemu.		PSU-242-5-01

## DODACI

<b>Spoljni detektor za temperaturu</b>				
	136709			ACC-005-O-01
<b>Unutrašnji detektor za temperaturu</b>				
	136710			ACC-004-O-01
<b>Spoljni detektor za vlažnost, 0-10V</b>				
	136711			ACC-007-A-01
<b>Unutrašnji detektor za vlažnost, 0-10V</b>				
	136712		HotCold	ACC-006-A-01
<b>Elektroventil za vodu 3/4", 230V, NC</b>				
		U slučaju poplave, kontrolni modul daje komandu elektroventilu da ugasi vodu u objektu		ACC-008-R-01
<b>Elektro termalni ventil - aktuator, M30x1.5, 230V, NC</b>				
	136713	Koristi se za nezavisnu kontrolu temperature prostorije, montira se na radijatore		ACC-014-R-01
<b>Bežični detektor za prozore i vrata, Z-Wave</b>				
	136714	Koristi se za detekciju i status otvoren/zatvoren, montira se na vratima i prozorima		INF-001-Z-01
<b>Bežični detektor pokreta, Z-Wave</b>				
	136717	Koristi se za detekciju pokreta, bežična konekcija sa sistemom preko Z-Wave mreže		INF-002-Z-01

## DODACI

Slika	Sifra	Naziv	Marka	Model
	136718	<b>Bežični detektor poplave, Z-Wave</b> Koristi se za detekciju vode u prostoru, bežična konekcija sa sistemom preko Z-Wave mreže		INF-003-Z-01
	136719	<b>Bežični sirena, Z-Wave</b>		INF-004-Z-01
		<b>Bežični detektor dima, Z-Wave</b> Koristi se za detekciju dima i požara u prostoru, bežična konekcija sa sistemom preko Z-Wave mreže		ACC-015-Z-01
	136720	<b>Antena L, Z-Wave, duža</b>		ACC-071-Z-01
		<b>Antena S, Z-Wave, kraća</b>		ACC-070-Z-01
		<b>BUS kabl, TF-Bus, 60 cm</b>		ACC-200-T-01
	136721	<b>BUS kabl, TF-Bus, 30 cm</b>		ACC-201-T-01
	136722	<b>BUS kabl, TF-Bus, 4 cm</b>		ACC-202-T-01
	136723	<b>TF-Bus kabl, 2x0.8 + (2x2x0.5), 200m</b>		TFB-200-T-01
	136724	<b>Kofer za Trening</b> Komplet osnovnih modula, instaliranih u metalnom koferu, za potrebe treninga i prezentacija		GTM-005-M-01
	136725	<b>Smart panel na drvenom nosaču</b>		ACC-016-E-01